

CAM-561

Water-proof Junction Box



Features

- Aesthetic design
- Material: aluminum
- Water-proof junction box

Technical Specifications

Model	CAM-561
General	
Material	Aluminum
Dimension	Φ122.0mmx34.2mm (Φ4.80"x1.35")
Inch Thread	M20(G1/2")
Load Bearing	1.0kg(2.2lb)
Weight	0.24kg(0.53lb)
Color	White
Operating Temperature	-40°C~+60°C(-40°F~+140°F)
Humidity	<90% RH

Dimensions (mm/inch)

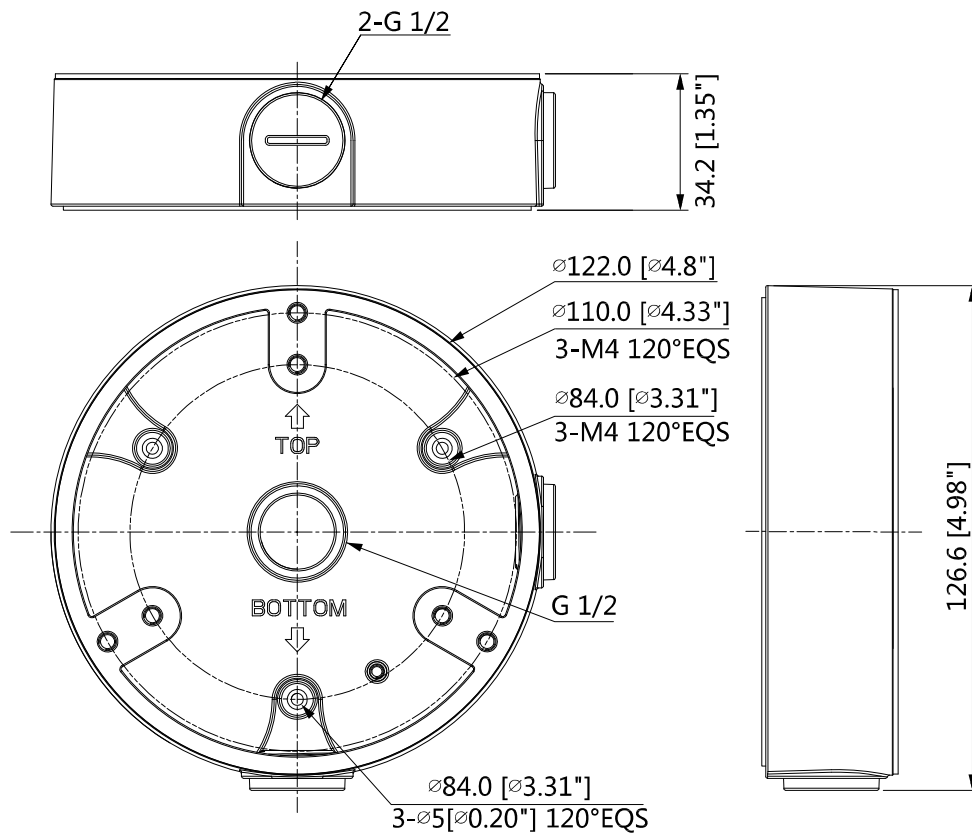

Application

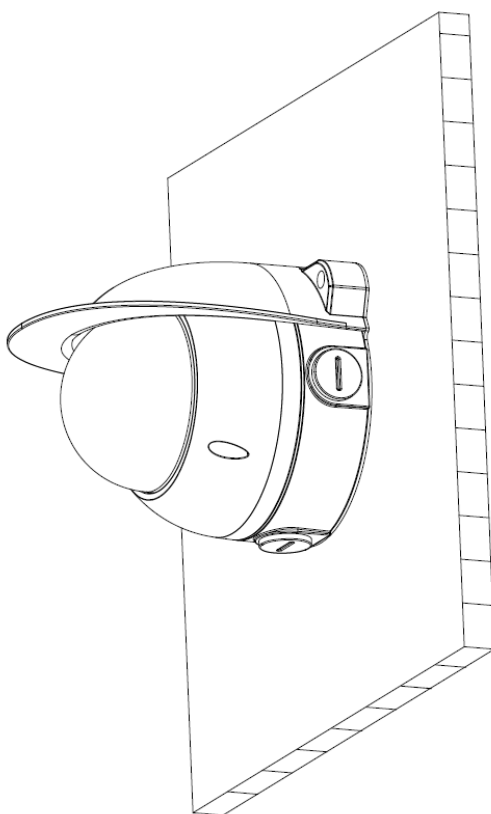

Package Information

- Water-proof junction box *1
- M4x12 screw *3
- ST4x25 screw *3
- Plastic anchor: 3
- Water joint *1
- Wrench *1